

 **DEAGOSTINI**



The logo for Deagostini, featuring a stylized red 'D' symbol followed by the word 'DEAGOSTINI' in a bold, italicized, red sans-serif font. Below the logo, there are two horizontal bars: a green one on the left and an orange one on the right.

DEAGOSTINI

Per ragioni di ordine tecnico o stilistico Deagostini Inox si riserva il diritto di modificare, senza preavviso, nelle forme e nelle dimensioni, gli oggetti inseriti nel presente catalogo.

Deagostini Inox reserves the right, without prior notice, to modify for technical and stylistic reasons the design and measures of the items shown in this catalogue.

Deagostini Inox se reserva el derecho de cambiar, sin previo aviso, el diseño y las medidas de los artículos incluidos en este catálogo por razones técnicas o de estilo.

Deagostini Inox se réserve le droit de modifier sans information préalable, pour motifs d'ordre technique ou de style, les objets présentés dans ce catalogue.

Il design moderno e minimale contraddistingue la nuova collezione buffet caratterizzata dalla massima flessibilità di utilizzo e da una vasta scelta di accessori tra loro coordinati, ideati per ospitare ogni evento della giornata, dalla prima colazione al pranzo, dal brunch alla cena. La modularità delle basi permette la creazione di composizioni complete e funzionali per il mantenimento dei cibi caldi e freddi, la distribuzione delle bevande e la presentazione dei piatti, il tutto organizzato secondo una precisa logica di utilizzo. I moduli possono essere completati con raccordi in vetro che oltre a dare un tocco di raffinatezza, assolvono alla funzione di piani di appoggio. Le basi sono realizzate in MDF nel colore nero e bianco, con una speciale verniciatura ad acqua, abbinata a vassoi e contenitori in acciaio inox 18/10, vetro float e policarbonato che esaltano la presentazione di ogni pietanza con una nota di raffinatezza.

[18/10] Acciaio Inox - Aisi 304

La materia prima ci viene fornita da acciaierie Europee, certificata per uso alimentare in rispetto alle normative vigenti nel settore ristorazione. Adatto al lavaggio in lavastoviglie.

[MDF] Medium density fibreboard

Questo materiale è un derivato del legno; per mantenere integra la qualità devono essere usate alcune precauzioni quali:

- non mettere il prodotto a contatto con l'acqua per un lungo periodo;
- non utilizzare prodotti abrasivi per la pulizia ma solo un panno inumidito con acqua;
- evitare lunghe esposizioni al sole che potrebbero causare deformazioni al prodotto.

[PC] Policarbonato

Il policarbonato è un generico poliestere dell'acido carbonico con particolari proprietà quali trasparenza, durezza, resistenza all'urto e alla rottura. Garantito per l'utilizzo a contatto con gli alimenti, resiste all'acqua fino a 70°C, agli alcoli ma non all'alcool metilico, all'acetone, al benzolo ed alle soluzioni alcaline.

The modern and minimalist design distinguishes the new buffet collection characterized by maximum flexibility of use and a wide choice of coordinated accessories, designed to accommodate every event of the day, from breakfast to lunch, from brunch to dinner. Bases modularity allows the creation of complete and functional compositions, for the preservation of hot and cold food, beverage distribution and dishes presentation, all organized according to a specific logic based on the use. Forms can be filled with glass fittings that as well as giving a touch of sophistication, fulfilling the function of support base. Bases are made in black or white MDF, with a special water painting, combined with stainless steel 18/10 trays and vessels, float glass and polycarbonate that enhance the presentation of each dish with a touch of sophistication.

[18/10] Stainless steel - Aisi 304

European steelworks supplied us with the raw material, food use certified, in compliance with standards in the catering sector. Dishwasher proof.

[MDF] Medium density fibreboard

This material is a derivative of wood; to maintain the quality, precautions should be used:

- do not put the product in contact with water for a long period;
- do not use abrasive cleaning products but only a water moistened cloth;
- avoid long exposures to sun that may cause product deformation.

[PC] Polycarbonate

Polycarbonate is a generic polyester of carbonic acid with specific properties such as transparency, hardness, impact and breakage resistance. Guaranteed for use in contact with food, water resistant up to 70°C, to alcohols but not to methyl alcohol, acetone, benzol and alkaline solutions.

El diseño moderno y minimalista caracteriza la nueva colección buffet que se señala por una particular flexibilidad de empleo y por una grande elección de accesorios coordinados y ideados para satisfacer cada momento del día, del desayuno al almuerzo, del brunch a la cena. La modularidad de las bases permite la creación de composiciones completas y funcionales para mantener comidas caldas y frías, para la distribución de bebidas y para la presentación de los platos, cada función está organizada según una precisa lógica de empleo. Los módulos pueden ser completados con empalmes de vidrio que funcionan como planos de apoyo y dan un toque de fineza. Las bases son realizadas en MDF de color negro y blanco, con una pintura especial al agua; están combinadas con bandejas y contenedores de acero inoxidable 18/10, vidrio float, policarbonato, que exaltan la presentación de cada plato con un toque de elegancia.

[18/10] Acero inoxidable - Aisi 304

La materia prima es proveída por acererías europeas; está certificada para uso alimenticio conforme según la normativa vigente. Puede ser lavado en lavavajillas.

[MDF] Medium density fibreboard

Esta materia es un derivado de la madera; es necesario tomar algunas precauciones para mantener toda su calidad:

- no deje el producto al contacto con el agua por mucho tiempo;
- no utilice productos abrasivos para limpiarlo, utilice solo un paño húmedo;
- evite de dejar el producto expuesto al sol por mucho tiempo, eso podría causar deformaciones.

[PC] Policarbonato

El policarbonato es un poliéster del ácido carbónico con propiedades particulares como la transparencia, la dureza, la resistencia a los choques y a las roturas. Está garantizado para uso alimenticio, es resistente al agua hasta 70°C, a los alcoholes, pero no lo es al alcohol metílico, a la acetona, al benceno y a las soluciones alcalinas.

Le design moderne et épuré marque la nouvelle collection buffet qui se caractérise par une très grande flexibilité d'utilisation et par un important choix d'accessoires coordonnés, conçus pour satisfaire chaque moment de la journée, du petit déjeuner au déjeuner, du brunch au dîner. La modularité des bases permet la création de compositions complètes et fonctionnelles pour le maintien de mets froids et chauds, pour la distribution des boissons et la présentation des plats; chaque fonction est organisée selon une logique d'utilisation très précise. Les modules peuvent être complétés par des raccords en verre qui en plus d'agir comme des plans d'appui, donnent une touche très raffinée à l'ensemble. Les bases sont réalisées en MDF couleur noir et blanc, peinture spéciale à l'eau. Elles sont assorties à des plateaux, à des bacs en acier inox 18/10, à du float-glass et à du polycarbonate compatible avec un usage alimentaire, qui exaltent la présentation des mets avec une touche de style et d'élégance.

[18/10] Acier Inox 18/10 – Aisi 304

La matière première est fournie par des aciéries européennes; elle est certifiée compatible avec un usage alimentaire, dans le plein respect des normes en vigueur dans le secteur de la restauration. Adaptée au lavage lave-vaisselle

[MDF] Medium density fibreboard

Cette matière est un dérivé du bois; pour maintenir toute sa qualité il faut prendre certaines précautions:

- ne pas la laisser trop longtemps au contact de l'eau.
- ne pas utiliser de produits abrasifs pour le nettoyage; utiliser uniquement un chiffon humide.
- éviter de l'exposer trop longtemps au soleil: cela pourrait lui causer des déformations.

[PC] Polycarbonate

Le polycarbonate est un générique polyester de l'acide carbonique avec des propriétés particulières telles que la transparence, la dureté, la résistance aux chocs et aux cassures. Il est garanti compatible avec un usage alimentaire, il est résistant à l'eau jusqu'à 70°C, aux alcools, mais pas à l'alcool méthylique, à l'acétone, au benzène et aux solutions alcalines.



taglia pañ

[GN1/1]

Tagliere pane.
Bread board.
Tabla corta pan.
Planche à pain.



R00050500000

Tagliere in legno europeo.
European wood chopping board.
Picador de madera europea.
Plache à découper en bois européen.

R00050206500

Vasca raccogli-briciole PC h mm 65.
PC crumb-container h mm 65.
Fuente recoje-migas PC h mm 65.
Bac ramasse-miettes PC h mm 65.

R00050100040

Base di supporto in MDF.
MDF support base.
Base de apoyo en MDF.
Base de support en MDF.

■ 100020100050

□ 100020100040

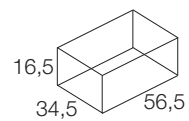

pécc

[GN1/1]

Distributore pane.
Bread-holder.
Panera.
Distributeur de pain.

■ 100020400050

□ 100020400040

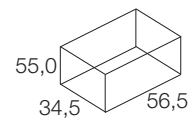

R00050800000

Vassoio con cilindri portapane in PC
e coperchi in acciaio inox.
Tray with bread holder in PC
and lids in stainless steel.
Bandeja con contenedores en PC para el pan
y tapas de acero inoxidable.
Plateau avec cylindres de PC pour pain
et couvercles en acier.

R00050100050

Base di supporto in MDF.
MDF support base.
Base de apoyo en MDF.
Base de support en MDF.



marmilaa

[GN1/1]

Espositore per spremute e marmellate.

Stand for juices and jams.

Espositor para zumos y mermeladas.

Présentoir pour jus pressé et confiture.

■ 100020800050

□ 100020800040

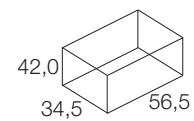

R00052100050

Vassoio in MDF completo di 6 piattini in acciaio inox, 2 caraffe in metacrilato da lt 2.3 con portaggiaccio e 4 barattoli in vetro.

MDF tray with 6 small stainless steel plates, 2 methacrylate pitchers lt 2.3 with ice holder and 4 glass pots.

Plancha de MDF con 6 posavasos de acero inoxidable, 2 jarras lt 2.3 de metacrilado con contenidor por hielo y 4 tarros de vidrio.

Plateau en MDF avec 6 petit plateaux en acier inox, 2 carafes lt 2.3 en méthacrylate avec récipient pour la glace et 4 pots en verre.

R00050100050

Base di supporto in MDF.

MDF support base.

Base de apoyo en MDF.

Base de support en MDF.

butèlj

[GN1/1]

Portabottiglie refrigerato.
Refrigerated bottle holder.
Porta botellas refrigerado.
Porte-bouteilles réfrigéré.

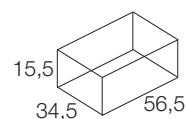

■ 100020700050

□ 100020700040

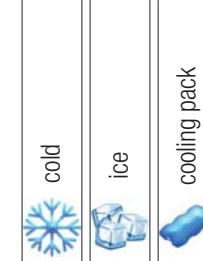

R00050900000

Vassoio in acciaio inox con otto fori.
Stainless steel tray with eight holes.
Bandeja de acero inoxidable con ocho agujeros.
Plateau en acier inox avec huit trous.

R00050300000

Falso fondo forato PC.
PC Perforated false bottom.
Doble fondo perforado PC.
Faux fond percé PC.

R00004700000 (3x)

Panetto eutettico.
Cooling pack.
Acumulador térmico.
Pains de glace.

R00050210000

Vasca PC h mm 100.
PC container h mm 100.
Fuente PC h mm 100.
Bac PC h mm 100.

R00050100040

Base di supporto in MDF.
MDF support base.
Base de apoyo en MDF.
Base de support en MDF.



furmèggia

[GN1/1]

Espositore formaggi con tagliere in legno.

Cheese service tray with wood chopping board.

Bandeja para queso con picador de madera.

Plateau pour fromages avec plache à découper en bois.

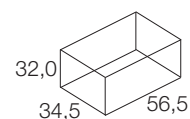

■ 100020200050

□ 100020200040

R00050400000

Cupola PC apertuta a 90°.

PC dome lid 90° opening.

Campana PC abertura 90°.

Cloche PC ouverture 90°.

R00050700000

Tagliere in legno europeo.

European wood chopping board.

Picador de madera europea.

Plache à découper en bois européen.

R00050600000

Vassoio in acciaio inox.

Stainless steel tray.

Bandeja en acero.

Plateau en acier.

R00050100050

Base di supporto in MDF.

MDF support base.

Base de apoyo en MDF.

Base de support en MDF.

sérop

[GN1/1]

Portafrutta.
Fruit-holder.
Frutero.
Porte-fruits.



■ 100020300050

□ 100020300040

R00051000000

Vassoio con portafrutta in acciaio inox.
Stainless steel tray with fruits-holder.
Bandeja de acero inoxidable con frutero.
Plateau en acier inox avec porte-fruits.

R00050100040

Base di supporto in MDF.
MDF support base.
Base de apoyo en MDF.
Base de support en MDF.

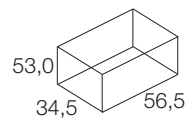

furcillin

[GN1/1]

Portaposate a 3 scomparti.
Cutlery holder with 3 compartments.
Portacubiertos a 3 compartimentos.
Porte-couverts à 3 compartiments.

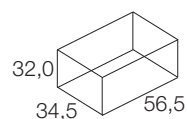

■ 100022500050

□ 100022500040

R00050400000

Cupola PC apertura a 90°.
PC dome lid 90° opening.
Campana PC abertura 90°.
Cloche PC ouverture 90°.

100011306500 (3x)

Vasca in acciaio inox GN1/3 h mm 65.
Stainless steel basin GN1/3 h mm 65.
Cubo de acero inoxidable GN1/3 h mm 65.
Bac en acier inox GN1/3 h mm 65.

R00050100050

Base di supporto in MDF.
MDF support base.
Base de apoyo en MDF.
Base de support en MDF.

tücc i früt

[GN1/1]

Set macedonia refrigerato.

Refrigerated set for salad-fruits.

Espositor refrigerado para ensalada de fruta.

Présentoir pour salade de fruits réfrigéré.

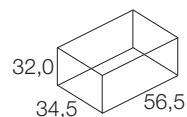

■ 100020500050

□ 100020500040

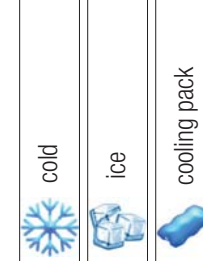

R00050400000

Cupola PC apertura a 90°.
PC dome lid 90° opening.
Campana PC abertura 90°.
Cloche PC ouverture 90°.

R00051100000

Vassoio in acciaio inox
con due ciotole in vetro Ø cm 21.
Stainless steel tray
with two glass bowls Ø cm 21.
Bandeja de acero inoxidable
con dos bols de vidrio Ø cm 21.
Plateau en acier inox
avec deux bols en verre Ø cm 21.

R00050300000

Falso fondo forato PC.
PC Perforated false bottom.
Doble fondo perforado PC.
Faux fond percé PC.

R00004700000 (3x)

Panetto eutettico.
Cooling pack.
Acumulador térmico.
Pains de glace.

R00050210000

Vasca PC h mm 100.
PC container h mm 100.
Fuente PC h mm 100.
Bac PC h mm 100.

R00050100050

Base di supporto in MDF.
MDF support base.
Base de apoyo en MDF.
Base de support en MDF.





büür

[GN1/1]

Portaburro e marmellata refrigerato.

Refrigerated stand for butter and jam.

Bandeja refrigerada para mantequilla y marmelada.

Présentoir pour beurre et confiture réfrigéré.

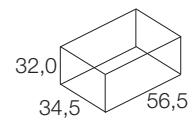

■ 100020900050

□ 100020900040

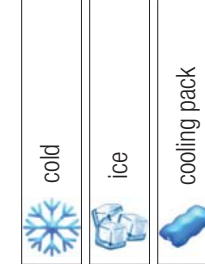

R00050400000

Cupola PC apertura a 90°.
PC dome lid 90° opening.
Campana PC abertura 90°.
Cloche PC ouverture 90°.

R00051200000

Vassoio forato in acciaio inox.
Stainless steel perforated tray.
Bandeja perforada de acero inoxidable.
Plateau percé en acier inox.

R00004700000 (3x)

Panetto eutettico.
Cooling pack.
Acumulador térmico.
Pains de glace.

R00050206500

Vasca PC h mm 65.
PC container h mm 65.
Fuente PC h mm 65.
Bac PC h mm 65.

R00050100050

Base di supporto in MDF.
MDF support base.
Base de apoyo en MDF.
Base de support en MDF.



cirighin

[GN1/1]

Portauova.
Eggs-holder.
Porta-huevos.
Porte-oeufs.

■ 1000**215**000**50**

□ 1000**215**000**40**



R00051300000

Vassoio in acciaio inox con fori per 45 uova.

Pierced stainless steel tray for 45 eggs.

Bandeja perforada de acero inoxidable para 45 huevos.

Plateau percé en acier inox pour 45 oeufs.

R000501000**40**

Base di supporto in MDF.

MDF support base.

Base de apoyo en MDF.

Base de support en MDF.

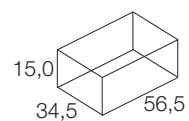

quagiàì e ööu

[GN1/1]

Porta uova e yogurt refrigerato.

Refrigerated tray for yoghurt and eggs.

Porta yogur y huevos refrigerado.

Porte-yaourt et œufs réfrigéré.

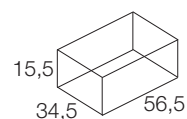

■ 1000**216**000**50**

□ 1000**216**000**40**

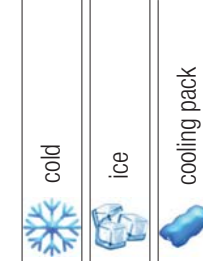

R00051400000

Vassoio con fori per 20 uova e 12 yogurt.

Pierced tray for 20 eggs and 12 yoghurt.

Bandeja perforada para 20 huevos y 12 yogur.

Plateau perce pour 20 oeufs et 12 yaourt.

R00050300000

Falso fondo forato PC.

PC Perforated false bottom.

Doble fondo perforado PC.

Faux fond percé PC.

R00004700000 (3x)

Panetto eutettico.

Cooling pack.

Acumulador térmico.

Pains de glace.

R00050206500

Vasca PC h mm 65.

PC container h mm 65.

Fuente PC h mm 65.

Bac PC h mm 65.

R00050100040

Base di supporto in MDF.

MDF support base.

Base de apoyo en MDF.

Base de support en MDF.

quagiàì 22

[GN1/1]

Porta yogurt refrigerato.
Refrigerated yoghurt bowls.
Porta yogur refrigerado.
Porte-yaourt réfrigéré.

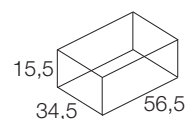

■ 100021100050

□ 100021100040

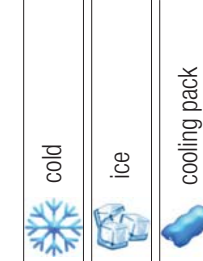

R00051500000

Vassoio con fori per 22 yogurt.
Pierced tray for 22 yoghurt.
Bandeja perforada para 22 yogur.
Plateau perce pour 22 yaourt.

R00050300000

Falso fondo forato PC.
PC Perforated false bottom.
Doble fondo perforado PC.
Faux fond percé PC.

R00004700000 (3x)

Panetto eutettico.
Cooling pack.
Acumulador térmico.
Pains de glace.

R00050206500

Vasca PC h mm 65.
PC container h mm 65.
Fuente PC h mm 65.
Bac PC h mm 65.

R00050100040

Base di supporto in MDF.
MDF support base.
Base de apoyo en MDF.
Base de support en MDF.

quagliaa

[GN1/1]

Portayogurt refrigerato.
Refrigerated basin for yoghurt.
Porta-yogur refrigerado.
Porte yaourt réfrigéré.

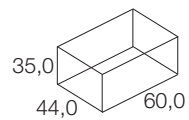

■ 100021000050

□ 100021000040

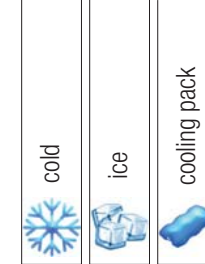

R00050400000

Cupola PC apertura a 90°.
PC dome lid 90° opening.
Campana PC abertura 90°.
Cloche PC ouverture 90°.

100011306500 (3x)

Vasca in acciaio inox GN1/3 h mm 65.
Stainless steel basin GN1/3 h mm 65.
Cubo de acero inoxidable GN1/3 h mm 65.
Bac en acier inox GN1/3 h mm 65.

R00004700000 (3x)

Panetto eutettico.
Cooling pack.
Acumulador térmico.
Pains de glace.

R00051800000

Vasca in acciaio inox.
Stainless steel basin.
Cubo de acero inoxidable.
Bac en acier inox.

R00055300050

Base di supporto in MDF.
MDF support base.
Base de apoyo en MDF.
Base de support en MDF.





ciòca

[GN1/1]

Portachampagne.
Champagne holder.
Cubos champagne.
Seaux à champagne.



R00051600000

Vassoio con due secchi champagne in acciaio inox.
Tray with two champagne buckets in stainless steel.
Bandeja de acero inoxidable con dos cubos champagne.
Plateau en acier inox avec deux seaux à champagne.

R00050100040

Base di supporto in MDF.
MDF support base.
Base de apoyo en MDF.
Base de support en MDF.

■ 100021200050

□ 100021200040

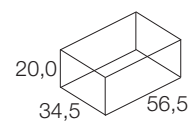

curniș

Espositore buffet.
Three floors stand.
Mostrador buffet.
Présentoir buffet.

■ 100876300050

□ 100876300040



100821200070 (3x)
Piano rettangolare in vetro float cm 61x50.
Rectangular tray in float glass cm 61x50.
Bandeja rectangular de vidrio float cm 61x50.
Plateau rectangulaire en verre float cm 61x50.

R00023800050
Struttura per espositore buffet.
Buffet stand structure.
Estructura para mostrador buffet.
Structure pour présentoir buffet.

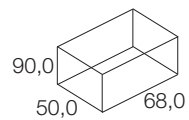



migliécc

Piano caldo.
Heating plate.
Placa calentadora.
Plateau chauffant.

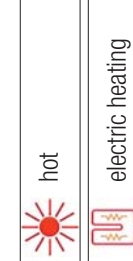

R00052500000

Piano caldo in vetro
con termostato regolabile - 600W MAX.
Glass heating plate
with adjustable thermostat - 600W MAX.
Placa calentadora de vidrio
con termostato regulable - 600W MAX.
Plateau chauffant en verre
avec thermostat réglable - 600W MAX.

R00055200050

Base di supporto in MDF.
MDF support base.
Base de apoyo en MDF.
Base de support en MDF.

■ 100023000050

□ 100023000040

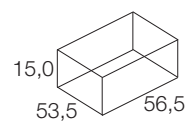









panicicc [GN1/1]

Set 2 zuppiere riscaldate a bagnomaria.
Set 2 pieces soup tureens, heated bain marie.
Sopera 2 ollas calentada bano maria.
Set de 2 soupières chauffées au bain marie.

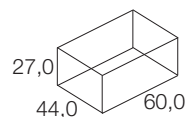

■ 100021400050

□ 100021400040

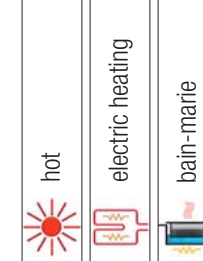

R00051700000

Vassoio con due zuppiere in acciaio inox.
Tray with two soup tureen in stainless steel.
Bandeja con dos sopera de acero inoxidable.
Plateau avec deux soupières en acier inox.

R00051800000

Vasca bagnomariain acciaio inox.
Stainless steel bain-marie top basin.
Cubo banomaria de acero inoxidable.
Bac bain-marie en acier inox.

R00055300040

Base di supporto in MDF.
MDF support base.
Base de apoyo en MDF.
Base de support en MDF.

100788738000

Piastra elettrica rettangolare
con termostato regolabile - 380W MAX.
Rectangular electrical resistance
with adjustable thermostat - 380W MAX.
Resistencia eléctrica retangular
con termostato regulable - 380W MAX.
Plaque électrique rectangulaire
avec thermostat réglable - 380W MAX.

caudröl

[GN1/1]

Scaldavivande rettangolare.
Rectangular chafing dish.
Calientaplatos rectangular.
Chauffe-plats rectangulaire.

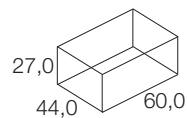

■ 1000**21300050**

□ 1000**21300040**

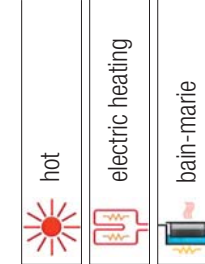

R000**54000000**

Scaldavivande GN1/1prof. mm 65,
coperchio in vetro e acciaio asportabile;
apertura a 90°.

Chafing dish GN1/1 depth mm 65,
removable stainless steel and glass lid;
opening 90°.

Calientaplatos GN1/1 prof. mm 65,
tapa de acero inox y vidrio desmontable;
abertura 90°.

Chauffe-plats GN1/1 prof. mm 65,
couverture en acier inox et verre démontable;
ouverture 90°.

R000**55100050**

Base di supporto in MDF.

MDF support base.

Base de apoyo en MDF.

Base de support en MDF.

100**788738000**

Piastra elettrica rettangolare
con termostato regolabile - 380W MAX.

Rectangular electrical resistance
with adjustable thermostat - 380W MAX.

Resistencia eléctrica rectangular
con termostato regulable - 380W MAX.

Plaque électrique rectangulaire
avec thermostat réglable - 380W MAX.



furnaca

[GN1/1]

Riscaldatore a infrarossi.
Infra-red heater.
Calientador infrarrojo.
Réchauffeur à infrarouge.

- 100021700050
- 100021700040

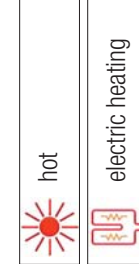
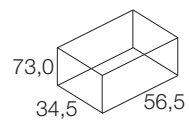

R00051900000
Vassoio in acciaio inox
con lampada a infrarossi 150W.
Stainless steel tray
with infra-red lamp 150W.
Bandeya de acero inoxidable
con lampara infrarrojo 150W.
Plateau en acier inox
avec lampe à infrarouge 150W.

R00050100040
Base di supporto in MDF.
MDF support base.
Base de apoyo en MDF.
Base de support en MDF.

fruta ó bicéer

[GN1/1]

Alzata a tre piani.
Three plates stand.
Frutero tres pisos.
Serviteur muet a trois étages.

■ 100020600050

□ 100020600040

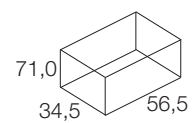

R00052200040

Alzata a tre piani per frutta e bicchieri.
Three plates stand for fruits and glasses.
Frutero tres pisos para fruta y vasos.
Serviteur a trois étages pour fruits et verres.

R00050100040

Base di supporto in MDF.
MDF support base.
Base de apoyo en MDF.
Base de support en MDF.

cu|jazzión

[GN1/1]

Vetrina neutra apribile da due lati.
Neutral display, two sides opening.
Vitrina neutra, abierta de dos adas.
Vitrine neutre ouvrant des deux côtés.

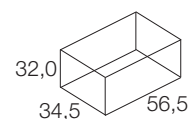

R00050400000
Cupola PC apertura a 90°.
PC dome lid 90° opening.
Campana PC abertura 90°.
Cloche PC ouverture 90°.

R00050600000
Vassoio in acciaio inox.
Stainless steel tray.
Bandeja en acero.
Plateau en acier.

R00050100050
Base di supporto in MDF.
MDF support base.
Base de apoyo en MDF.
Base de support en MDF.

■ 1000**23100050**

□ 1000**23100040**

licardaria

[GN1/1]

Vetrina refrigerata apribile da due lati.
Refrigerated display, two sides opening.
Vitrina refrigerada, abierta de dos adas.
Vitrine réfrigéré ouvrant des deux côtés.

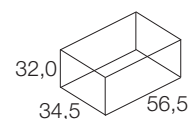

■ 1000**232**000**50**

□ 1000**232**000**40**

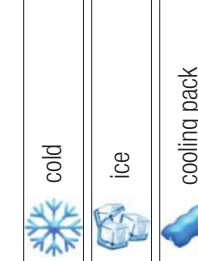

R000**504**00000

Cupola PC apertura a 90°.
PC dome lid 90° opening.
Campana PC abertura 90°.
Cloche PC ouverture 90°.

R000**506**00000

Vassoio in acciaio inox.
Stainless steel tray.
Bandeja en acero.
Plateau en acier.

R000**47**00000 (3x)

Panetto eutettico.
Cooling pack.
Acumulador térmico.
Pains de glace.

R000**502**06500

Vasca PC h mm 65.
PC container h mm 65.
Fuente PC h mm 65.
Bac PC h mm 65.

R000**501**00050

Base di supporto in MDF.
MDF support base.
Base de apoyo en MDF.
Base de support en MDF.



marénda

[GN1/1]

Vetrina riscaldata apribile da due lati.

Heated display, two sides opening.

Vitrina calentada, abierta de dos adas.

Vitrine chauffante, ouvrant des deux côtés.

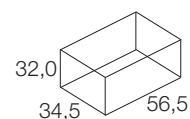

■ 1000**233**000**50**

□ 1000**233**000**40**

hot



electric heating



R00050400000

Cupola PC apertura a 90°.

PC dome lid 90° opening.

Campana PC abertura 90°.

Cloche PC ouverture 90°.

R00052000000

Vassoio in acciaio inox

predisposto per piastra elettrica.

Stainless steel tray

arranged for heating element.

Bandeja en acero

predispuesta para resistencia eléctrica.

Plateau en acier

prévu pour plaque électrique.

R000501000**50**

Base di supporto in MDF.

MDF support base.

Base de apoyo en MDF.

Base de support en MDF.

100**7887**0**50**00

Piastra elettrica rettangolare 50W.

Rectangular electrical resistance 50W.

Resistencia eléctrica rectangular 50W.

Plaque électrique rectangulaire 50W.



culjazzión 2 [GN1/1]

Vetrina neutra a due piani, apribile da due lati.
Neutral display two floors; two sides opening.
Vitrina neutra dos pisos; abierta de dos adas;
Vitrine neutre à deux niveaux; ouvrant des deux côtés.

■ 100023400050

□ 100023400040



R00050400000 (2x)
Cupola PC apertura a 90°.
PC dome lid 90° opening.
Campana PC apertura 90°.
Cloche PC ouverture 90°.

R00050600000 (2x)
Vassoio in acciaio inox.
Stainless steel tray.
Bandeja en acero.
Plateau en acier.

R00055000050
Base di supporto in MDF.
MDF support base.
Base de apoyo en MDF.
Base de support en MDF.

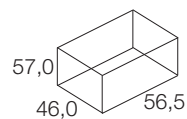

licardaria 2

[GN1/1]

Vetrina a due piani; inferiore refrigerata e superiore neutra. Apribili da due lati.

Two floors display; lower level refrigerated upper level neutral. Two sides opening.

Vitrina dos pisos refrigerada y neutra. Abierta de dos adas.

Vitrine à deux niveaux: niveau bas réfrigéré et niveau haut neutre. Ouvrant des deux côtés.

■ 100023500050

□ 100023500040

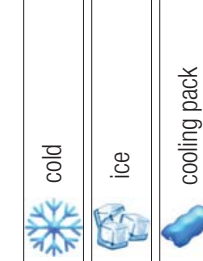
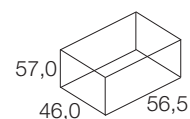

R00050400000 (2x)
Cupola PC apertura a 90°.
PC dome lid 90° opening.
Campana PC abertura 90°.
Cloche PC ouverture 90°.

R00050600000 (2x)
Vassoio in acciaio inox.
Stainless steel tray.
Bandeja en acero.
Plateau en acier.

R00004700000 (3x)
Panetto eutettico.
Cooling pack.
Acumulador térmico.
Pains de glace.

R00050206500
Vasca PC h mm 65.
PC container h mm 65.
Fuente PC h mm 65.
Bac PC h mm 65.

R00055000050
Base di supporto in MDF.
MDF support base.
Base de apoyo en MDF.
Base de support en MDF.





marénda 2 [GN1/1]

Vetrina a due piani. Inferiore riscaldata e superiore neutra. Apribile da due lati.
Display two floors; lower level heated upper level neutral. Two sides opening.
Vitrina dos pisos calentada y neutra. Abierta de dos adas.
Vitrine à deux niveaux: niveau bas chauffé et niveau haut neutre. Ouvrant des deux côtés.



■ 100023600050

□ 100023600040

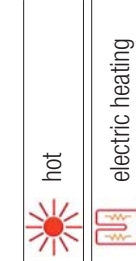
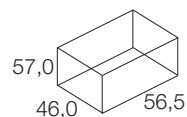

R00050400000 (2x)
Cupola PC apertura a 90°.
PC dome lid 90° opening.
Campana PC abertura 90°.
Cloche PC ouverture 90°.

R00050600000
Vassoio in acciaio inox.
Stainless steel tray.
Bandeja en acero.
Plateau en acier.

R00052000000
Vassoio in acciaio inox
predisposto per piastra elettrica.
Stainless steel tray
arranged for heating element.
Bandeja en acero
predispuesta para resistencia eléctrica.
Plateau en acier
prévüe pour plaque électrique.

R00055000050
Base di supporto in MDF.
MDF support base.
Base de apoyo en MDF.
Base de support en MDF.

100788705000
Piastra elettrica rettangolare 50W.
Rectangular electrical resistance 50W.
Resistencia eléctrica rectangular 50W.
Plaque électrique rectangulaire 50W.

malgón

[GN1/3]

Distributore cereali.
Cereal dispenser.
Dosificador cereales.
Distributeur de céréales.

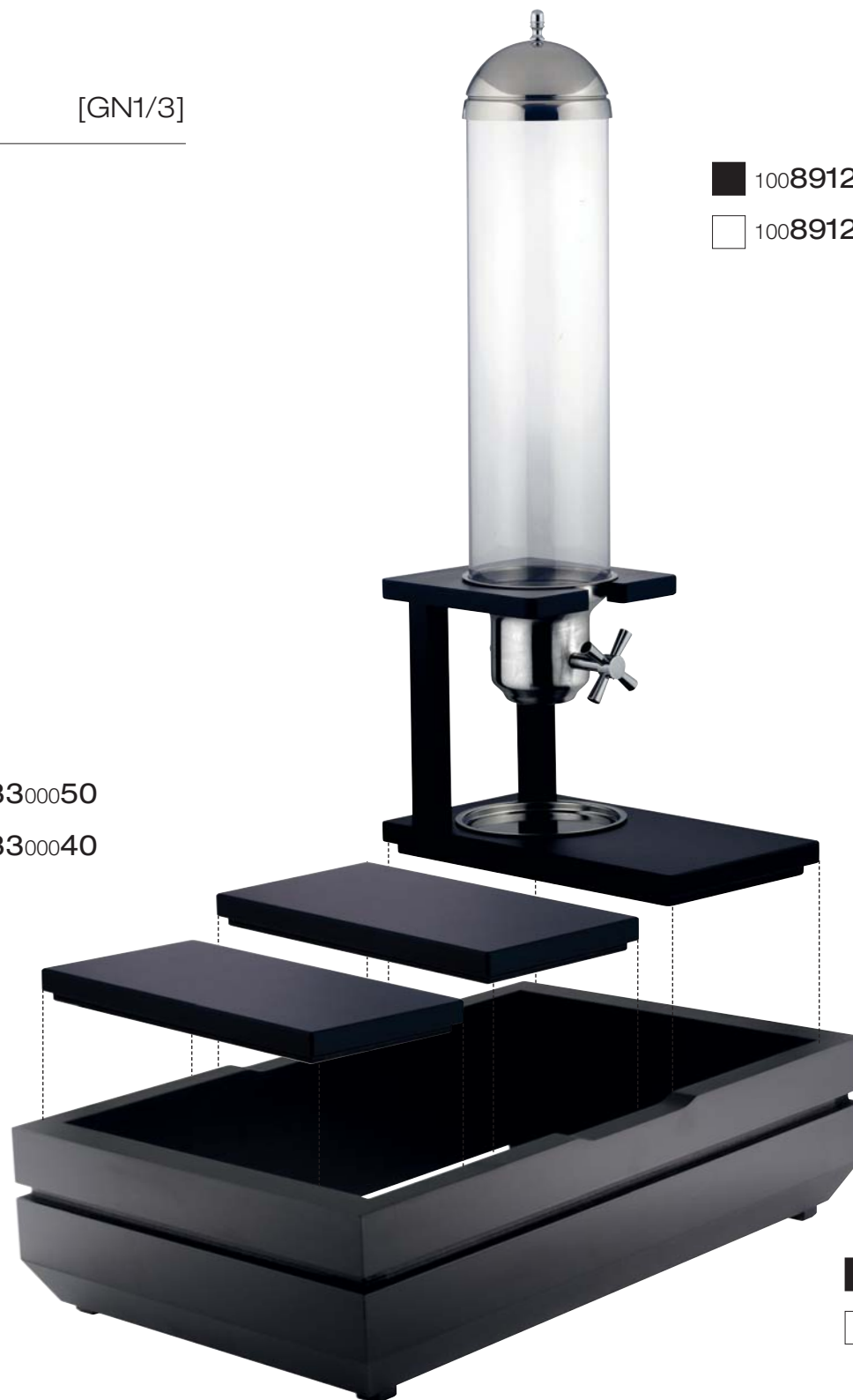

■ 100891200150

□ 100891200140

■ R00053300050

□ R00053300040

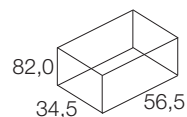

■ R00050100050

□ R00050100040

100891200150

Distributore cereali lt 5 con porzionatore,
struttura in MDF GN1/3.

One-portion cereal dispenser 5 lt
MDF structure GN1/3.

Dosificador cereales 5 lt,
estructura de MDF GN1/3.

Distributeur de céréales lt 5 avec régulateur portions,
structure en MDF GN1/3.

R00053300050

Piano in MDF GN1/3.

MDF top GN1/3.

Plano de MDF GN1/3.

Plateau en MDF GN1/3.

R00050100050

Base di supporto in MDF.

MDF support base.

Base de apoyo en MDF.

Base de support en MDF.

GN
1/3

GN
1/3

GN
1/3

portugàj [GN1/3]

Distributore spremute refrigerato.
Refrigerated fruit juice dispenser.
Dispensador zumos refrigerado.
Distributeur réfrigéré de fruits pressés.

■ 100890300150

□ 100890300140

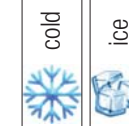

100890300150

Distributore spremute refrigerato 5 lt, struttura in MDF GN1/3.
Refrigerated fruit juice dispenser 5 lt, MDF structure GN1/3.
Dispensador zumos refrigerado 5 lt, estructura de MDF GN1/3.
Distributeur réfrigéré de fruits pressés 5 lt, structure en MDF GN1/3.

R00053300050

Piano in MDF GN1/3.
MDF top GN1/3.
Plano de MDF GN1/3.
Plateau en MDF GN1/3.

R00050100050

Base di supporto in MDF.
MDF support base.
Base de apoyo en MDF.
Base de support en MDF.

■ R00053300050

□ R00053300040



■ R00050100050

□ R00050100040

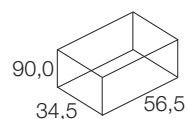

binis̄ [GN1/2]

Espositore per bustine.
Teabags stand.
Expositor para infusiones.
Présentoir pour sachets.

■ 100775800050

□ 100775800040

100775800050

Espositore per bustine con base in MDF GN1/2.
Teabags stand with MDF base GN1/2.
Expositor para infusiones con base de MDF GN1/2.
Présentoir pour sachets avec base en MDF GN1/2.

■ R00053200050

□ R00053200040

R00053200050

Piano in MDF GN1/2.
MDF top GN1/2.
Plano de MDF GN1/2.
Plateau en MDF GN1/2.

R00050100050

Base di supporto in MDF.
MDF support base.
Base de apoyo en MDF.
Base de support en MDF.

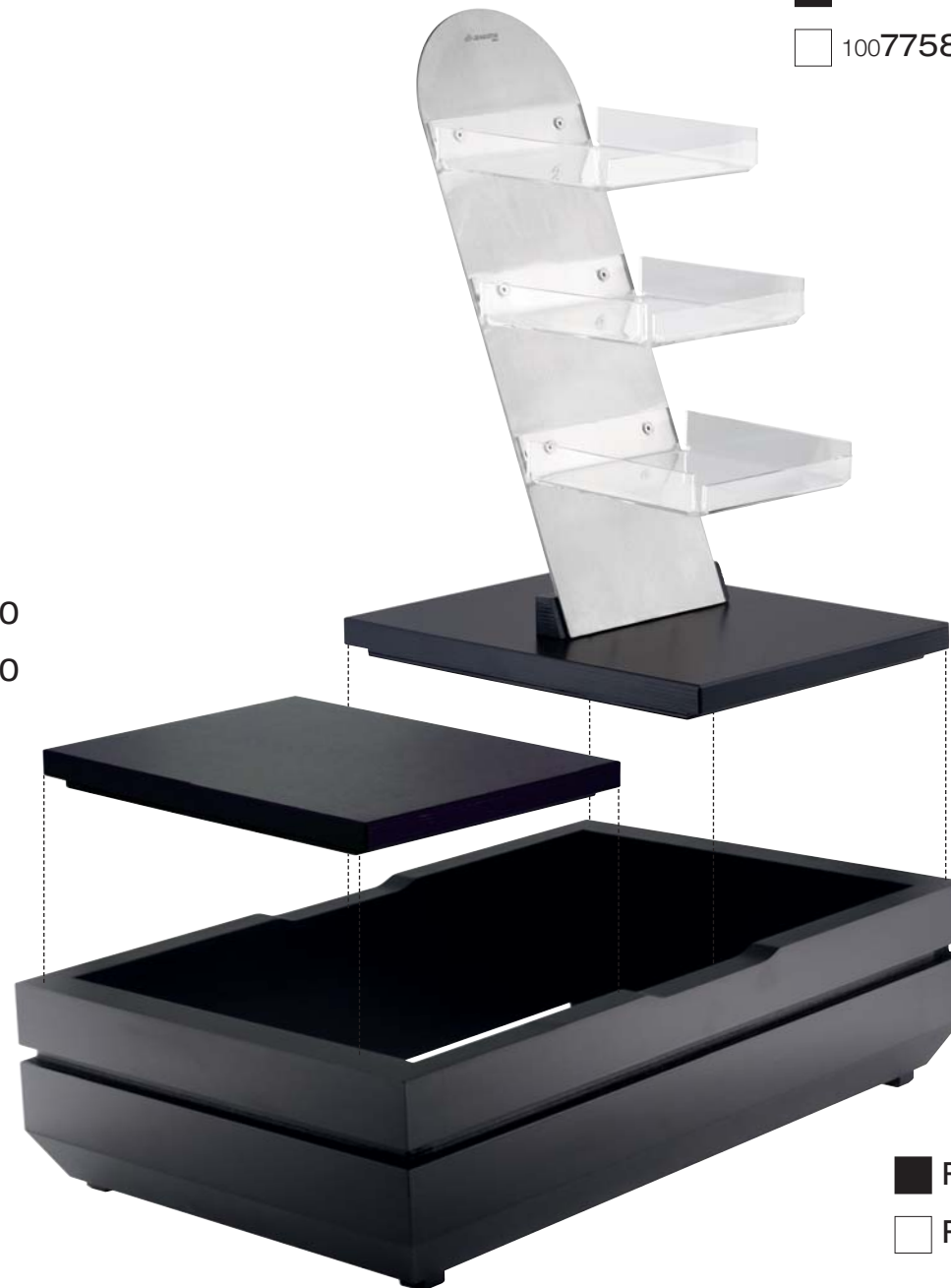

■ R00050100050

□ R00050100040

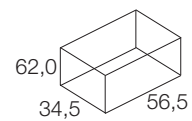



aiva spurca

[GN1/2]

Scaldacaffè/scaldalatte.
Coffee/milk warmer.
Dispensador café/leche caliente.
Chauffe-café/lait.

■ R00053200050

□ R00053200040

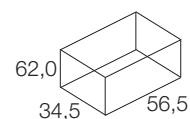

■ 100968200650

□ 100968200640

■ R00050100050

□ R00050100040

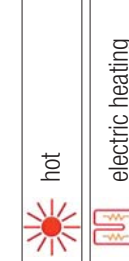

1009682000650

Scaldacaffè/scaldalatte lt 6
con base in MDF GN1/2.
Coffee/milk warmer 6 lt
with MDF base GN1/2.
Dispensador café/leche caliente lt 6
con base de MDF 1/2.
Chauffe-café/lait lt 6
avec base en MDF GN1/2.

100788800000

Piastra elettrica tonda 80W.
Round electrical resistance 80W.
Resistencia eléctrica redonda 80W.
Plaque électrique ronde 80W.

R00053200050

Piano in MDF GN1/2.
MDF top GN1/2.
Plano de MDF GN1/2.
Plateau en MDF GN1/2.

R00050100050

Base di supporto in MDF.
MDF support base.
Base de apoyo en MDF.
Base de support en MDF.

GN
1/2

GN
1/2





mungént

[GN1/2]

Distributore per latte refrigerato.
Refrigerated milk dispenser.
Dispensador leche refrigerado.
Distributeur de lait réfrigéré.

■ R00053200050

□ R00053200040

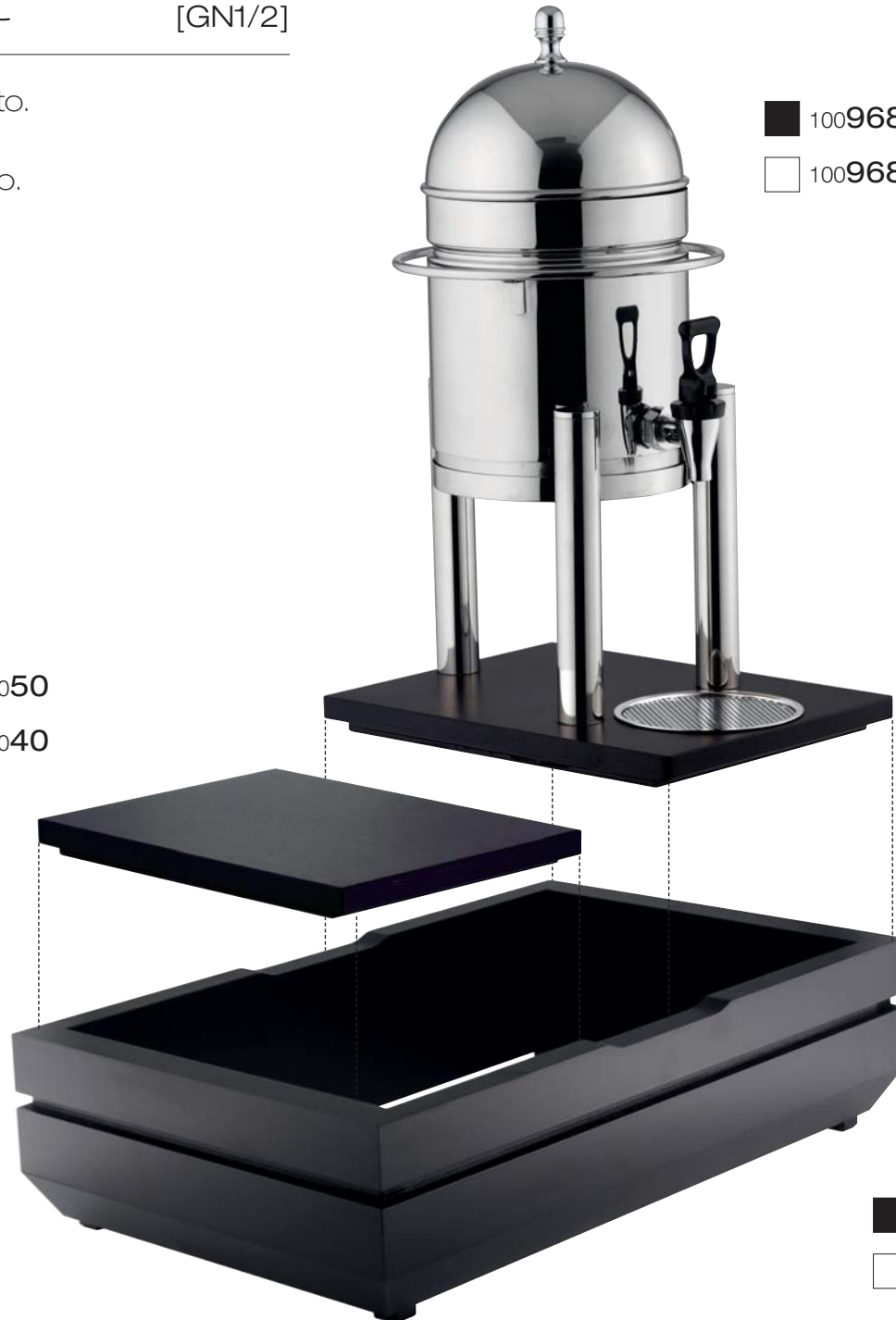

■ 100968300550

□ 100968300540



100968300550

Distributore per latte refrigerato lt 5
con base in MDF GN1/2.
Refrigerated milk dispenser 5 lt
with MDF base GN1/2.
Dispensador leche refrigerado lt 5
con base de MDF GN1/2
Distributeur de lait réfrigéré lt 5
avec base en MDF GN1/2.

R00053200050

Piano in MDF GN1/2.
MDF top GN1/2.
Plano de MDF GN1/2.
Plateau en MDF GN1/2.

R00050100050

Base di supporto in MDF.
MDF support base.
Base de apoyo en MDF.
Base de support en MDF.

■ R00050100050

□ R00050100040

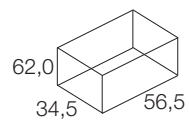

cavaggna

Portapane 3 cestini.
Bread-holder with 3 baskets.
Panera con 3 cestas.
Porte-pain avec 3 paniers.

■ 100874100050

□ 100874100040

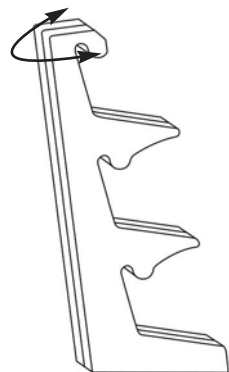

R00008000000 (3x)
Cestino in vimini Ø cm 44.
Wicker basket Ø cm 44.
Panera de mimbre Ø cm 44.
Panier pain Ø cm 44.

R00023900050
Base di supporto.
Support base.
Base de apoyo.
Base de support.

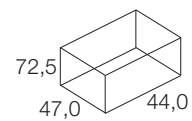

tutçòos

Espositore buffet.
Buffet display.
Mostrador buffet.
Présentori buffet.

■ 100876100050

□ 100876100040

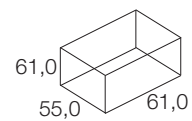
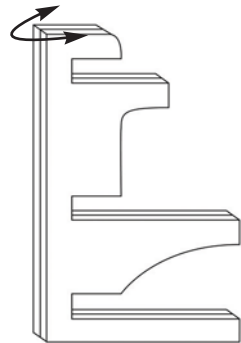

100821400070

Vassoio rettangolare in vetro float cm 34,5x25.
Rectangular tray in float glass cm 34,5x25.
Bandeja rectangular de vidrio float cm 34,5x25.
Plateau rectangulaire en verre float cm 34,5x25.

100821100070

Vassoio rettangolare in vetro float cm 56,5x34,5.
Rectangular tray in float glass cm 56,5x34,5.
Bandeja rectangular de vidrio float cm 56,5x34,5.
Plateau rectangulaire en verre float cm 56,5x34,5.

100821200070

Vassoio rettangolare in vetro float cm 61x50.
Rectangular tray in float glass cm 61x50.
Bandeja rectangular de vidrio float cm 61x50.
Plateau rectangulaire en verre float cm 61x50.

R00024000050

Base di supporto.
Support base.
Base de apoyo.
Base de support.

pasadóra

Vassoio rettangolare in vetro float.
Rectangular tray in float glass.
Bandeja rectangular en vidrio float.
Plateau rectangulaire en verre float.

100**8214**000**70**



100**8214**000**70**

Vassoio rettangolare in vetro float cm 34,5x25.
Rectangular tray in float glass cm 34,5x25.
Bandeja rectangular de vidrio float cm 34,5x25.
Plateau rectangulaire en verre float cm 34,5x25.

100**8211**000**70**



100**8211**000**70**

Vassoio rettangolare in vetro float cm 56,5x34,5.
Rectangular tray in float glass cm 56,5x34,5.
Bandeja rectangular de vidrio float cm 56,5x34,5.
Plateau rectangulaire en verre float cm 56,5x34,5.

tòc

Le basi di supporto possono essere impilate per ottimizzare lo spazio di stoccaggio.
The support bases could be arranged in a stack to optimize the space for storage.
Las bases sostenedoras pueden ser amontonadas para perfeccionar el espacio de l'almacenaje.
Les bases de support peuvent être empilées pour optimiser l'espace de stockage.



100788738000



100788705000



100788800000



R00050300000



R00004700000



R00050206500



R00050210000

100020100040	taglia pañ	page 7	100023000050	migliécc	page 30
100020200050	furmèggia	page 13	100023100050	cułazzión	page 40
100020300050	sérp	page 14	100023200050	licardaria	page 41
100020400050	pécc	page 8	100023300050	marénda	page 43
100020500050	tücc i früt	page 16	100023400050	cułazzion 2	page 45
100020600040	fruta ó bicéer	page 39	100023500050	licardaria 2	page 46
100020700040	butèlj	page 11	100023600050	marénda 2	page 49
100020800050	marmilaa	page 10	100775800050	binīş	page 52
100020900050	büür	page 19	100821100070	pasadóra	page 60
100021000050	quagiaa	page 24	100821400070	pasadóra	page 60
100021100040	quagiài 22	page 23	100874100050	cavaggna	page 58
100021200040	ciòca	page 27	100876100050	tutcòos	page 59
100021300050	caudröl	page 36	100876300050	curnīş	page 28
100021400040	panicìcc	page 35	100890300050	purtugàj	page 51
100021500040	cirighìn	page 21	100891200050	małgón	page 50
100021600040	quagiài e ööu	page 22	100968200050	aiva spurca	page 54
100021700040	furnaca	page 38	100968300050	mungént	page 57
100022500050	furcilìn	page 15			



...from 1946

DEAGOSTINI INOX S.R.L.

Via Comoli, 93/A
28887 Omegna (VB)
ITALY

Tel. +39 0323 862804

+39 0323 862991

Fax +39 0323 861591

<http://www.deagostini-inox.it>

e-mail: info@deagostini-inox.it